

改訂	個数	日付	変更内容	Rev.	担当
△					
▽					
▲					

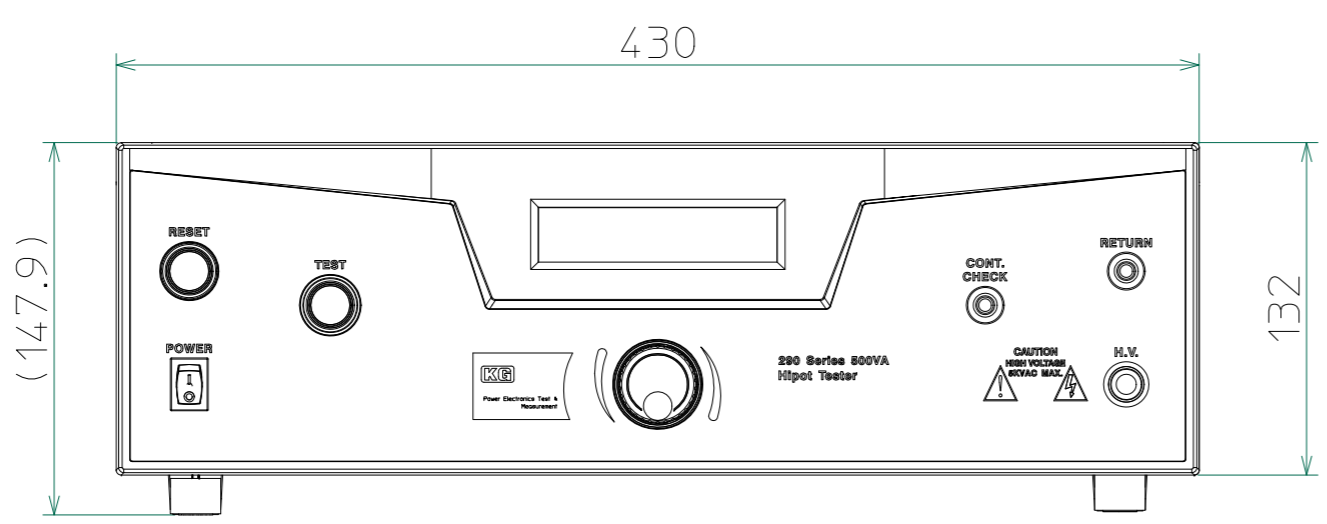
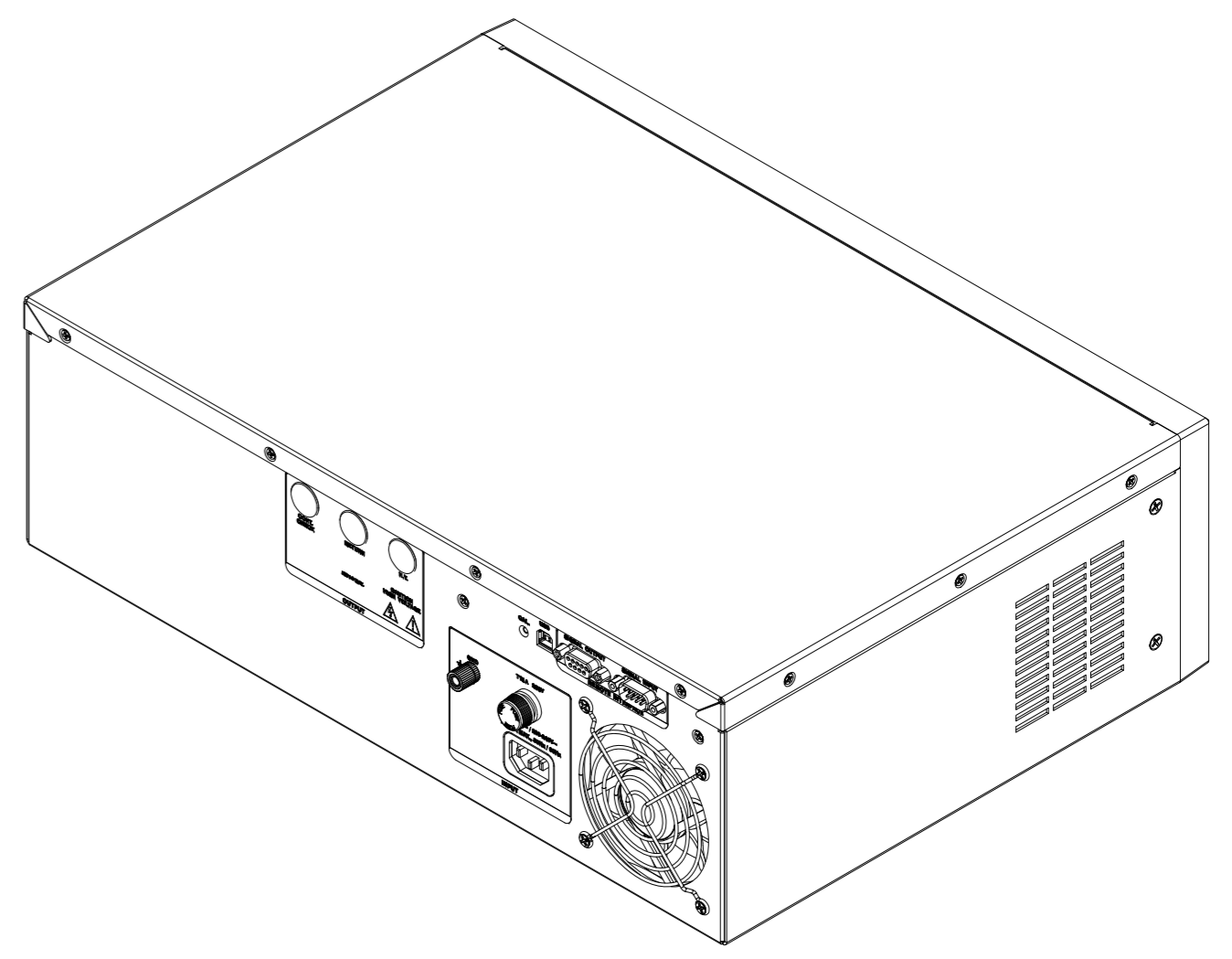
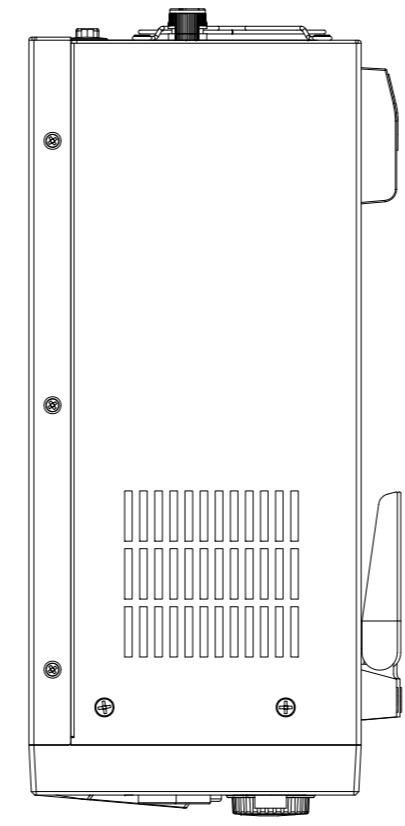
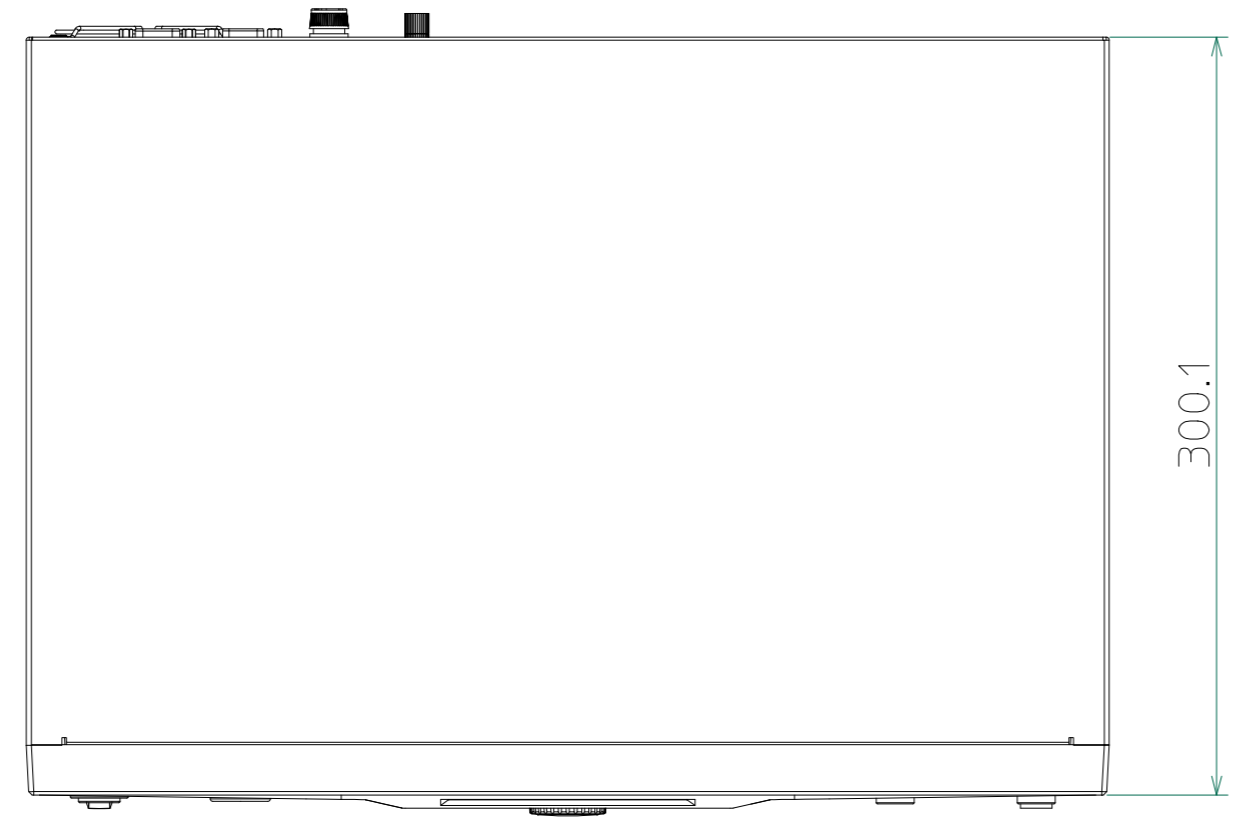
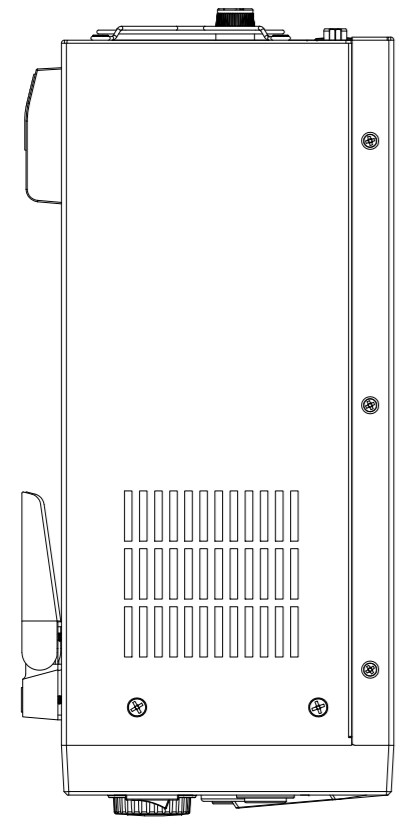
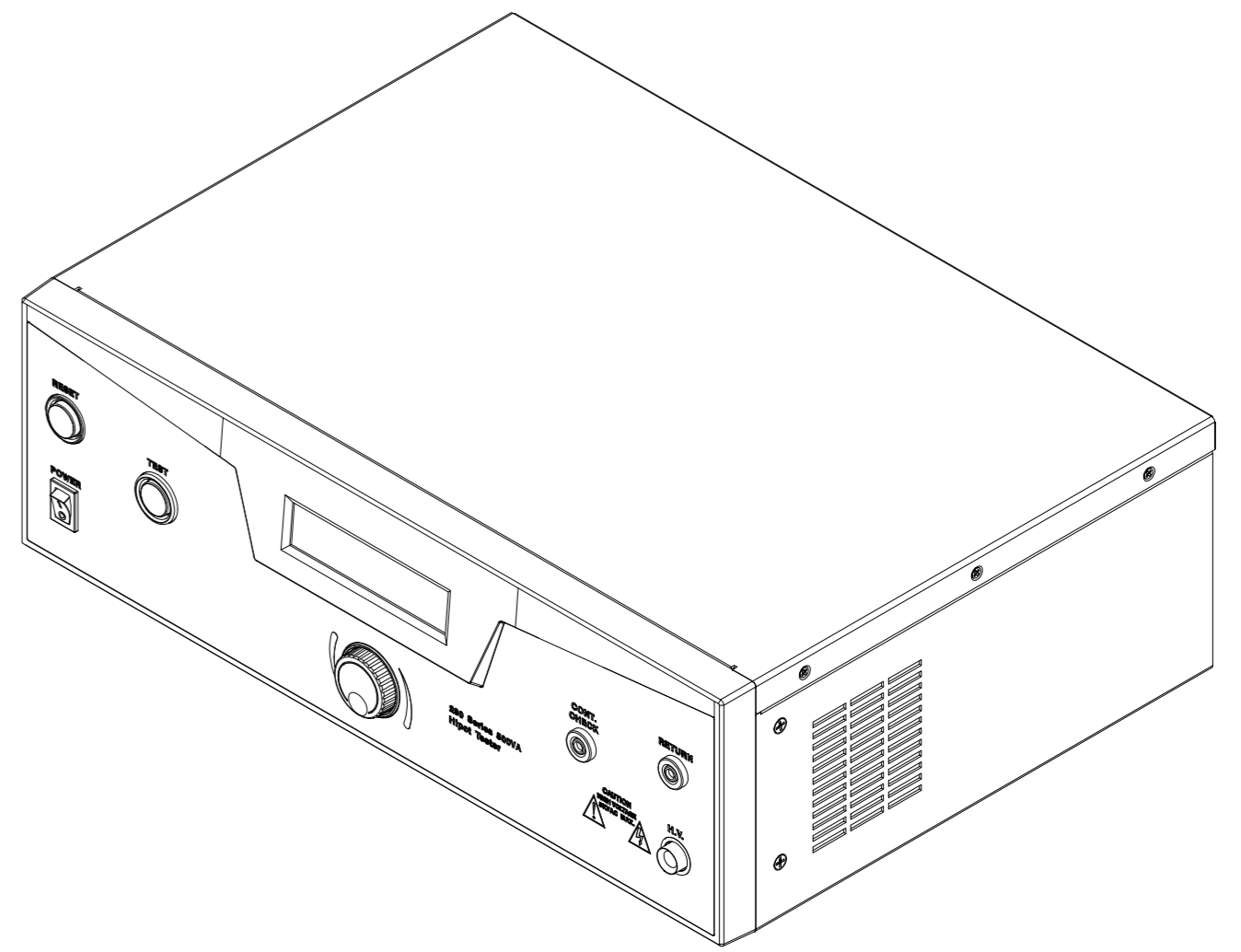
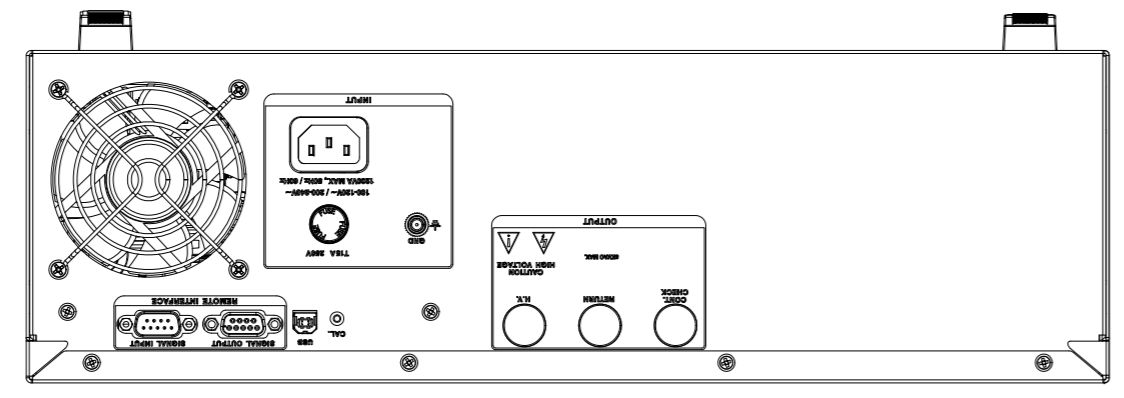

<SL-298.DXF>

材 質		処 理		指示ナキ	単位 mm
設計 2024/12/23 山本	確認	承認	品 名 298 外觀図	SHEETS 124/124	SCALE 1:3
			製 品 名 290シリーズ ポータブル安全試験器	図 番 KM2- P00602S - 124	Rev.